



THINK BEYOND WOOD®





We're leaving wood trim in the sawdust.

Homeowners want the look of real wood with none of the upkeep. Contractors want a product that's easy to work with and that they can trust. Klear® is here to make them both happy, giving builders and homeowners the best of both worlds—a rich, unique appearance with low-maintenance durability.

Workability

Klear doesn't just look like wood, it works like it. It goes up quickly and can be used in a number of applications including fascia, soffits, porch ceilings, wainscoting and more. You can even heat bend the boards to create truly unique designs.

100% Usable

Klear is engineered to perfection. That means there's no knots or other unusable pieces like you can have with wood. So when you buy a board, you can use the entire board.

Clean Application

When Klear goes up clean it stays brilliant for years to come. Our KlearPak® small quantity bundling and innovative TruEDGE® design helps to keep your boards clean on the job site so they can be installed for a perfect look.

KLEER PVC TRIMBOARDS

If you run out of ways to use Klear, you're not thinking hard enough.

If you can do it with wood, you can do it with Klear Trimboard®. Get architecturally correct corners, fascia, soffits, rakes, casings, cornices and all kinds of other applications, each with the distinctive look and beauty of wood without the upkeep or rot. And just like wood, you can nail it, staple it, glue it and bend it and, if you want to, even paint it to create any piece of architectural millwork. Infused with UV inhibitors that provide long lasting protection, they are perfect for creating authentic accents with a look that will last for years to come.

TruEDGE®

Building homes can be a dirty job. So we created our innovative TruEDGE technology to give distributors, dealers and contractors a trimboard that can stand up to dust and dirt. TruEDGE is engineered to provide cleaner, smoother edges, and can be wiped clean easily, unlike wood and other PVC trimboards.



Results from a dirt intrusion test show how much easier Klear is cleaned compared to competitors.



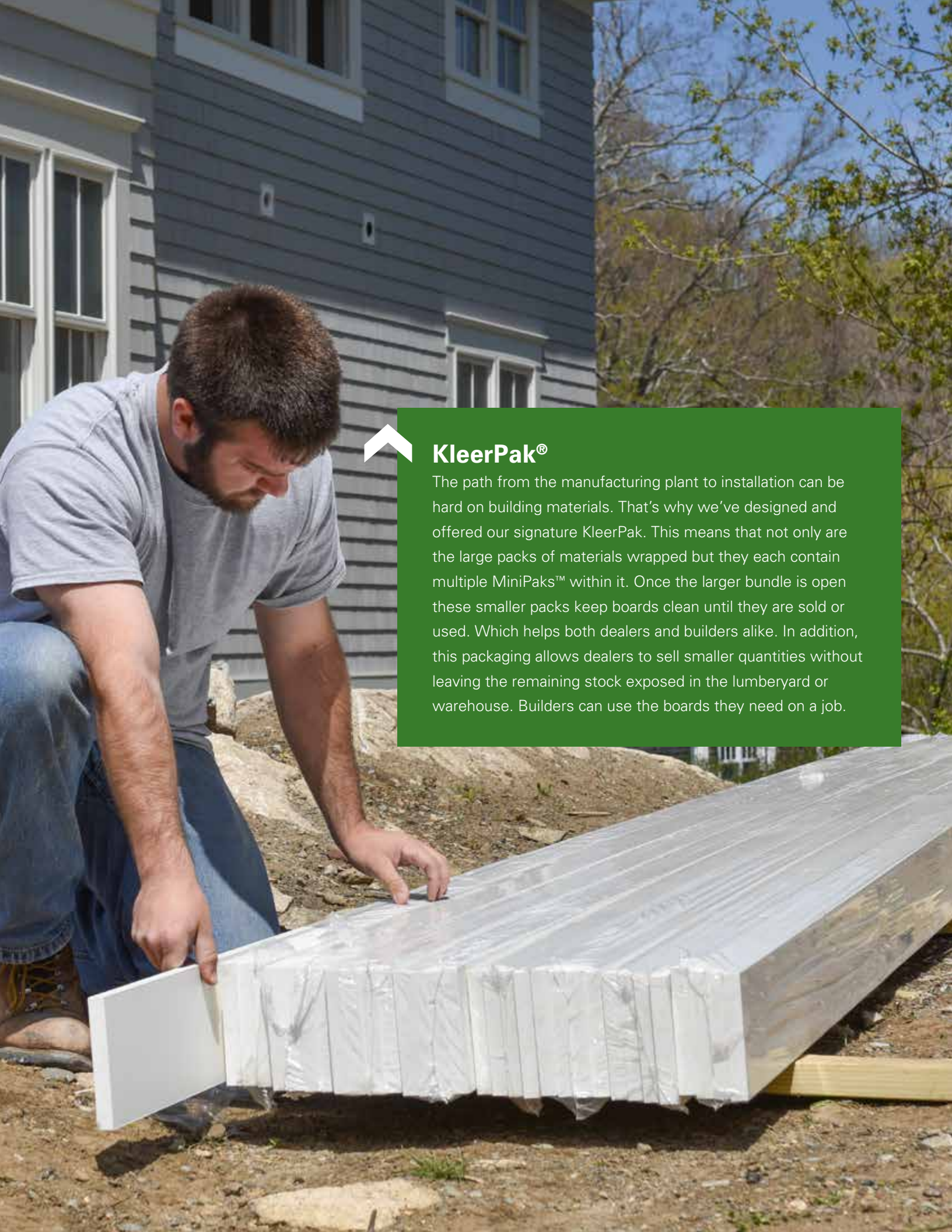

KleerPak®

The path from the manufacturing plant to installation can be hard on building materials. That's why we've designed and offered our signature KleerPak. This means that not only are the large packs of materials wrapped but they each contain multiple MiniPaks™ within it. Once the larger bundle is open these smaller packs keep boards clean until they are sold or used. Which helps both dealers and builders alike. In addition, this packaging allows dealers to sell smaller quantities without leaving the remaining stock exposed in the lumberyard or warehouse. Builders can use the boards they need on a job.

Kleer Trimboard® with Nailing Flange Cutouts

Designed with a 1/4" cutout so they install flat over window nailing flanges for a more attractive finished product.



3-1/2" Flat with J

Integrated nailing flange forms a 3/4" J-channel for faster, easier installation.



Outside Corner with Integrated Nailing Flange

Integrated nailing flange forms a 3/4" pocket to conceal end cuts.

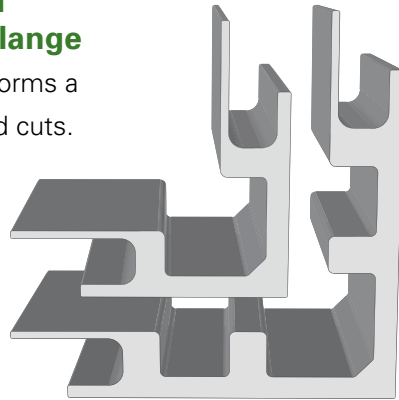

Kleer Corners®

Traditional trim corners are easy to install and offer the aesthetics of true mitered corners, in both smooth and woodgrain finish. Seamless, one-piece construction.

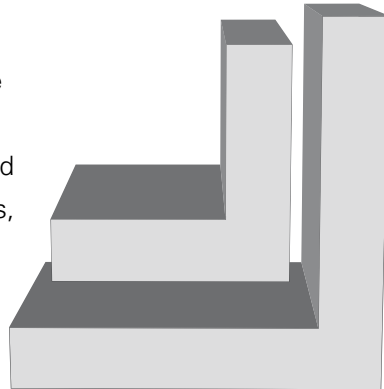



KLEERStart®

A 3/4" thick frieze board, the KLEERStart system allows siding to easily fit behind the trimboard, creating a seamless look.



Kleer Konceal®

The Konceal System is an innovative system of products from Kleer designed to save builders time and frustration without sacrificing a clean, finished look. These boards and corners have a built-in 3/4" reveal that covers rough cuts at corners as well as around windows and doors where precision cuts can be challenging. Kleer Konceal is available in smooth or natural woodgrain textures so you can pair it with vinyl, fiber cement or wood siding.

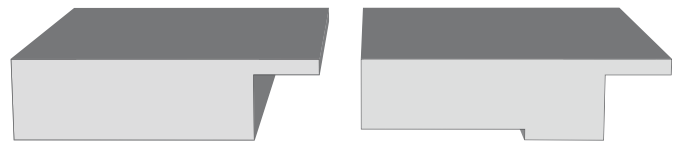

with nailing flange cutout

Kleer Konceal® Corners

A 3/4" reveal makes for easier siding installation and a clean, seamless look.



Like all our products, Klear Sheets and Custom Sheets won't warp, crack, split, rot, peel or flake, allowing them to have direct contact with the ground or other potentially wet surfaces.



Kleer saves builders time and money by eliminating the lamination steps, previously necessary for thicker PVC designs.

Kleer Sheets®

With a wide range of sizes and available thicknesses from 1/4" to 15/16", Kleer Sheets offer the versatility for a variety of millwork applications, as well as for framing out multiple windows and other custom uses.

Kleer Custom Sheets

Kleer 1-1/4" Sheets are perfect for pergola beams, corbels, mouldings, and any custom PVC millwork.



KLEERWRAP POST WRAPS

With KLEERWrap[®], it's like wooden posts have a protective force field. We're talking superhero-level stuff here.

Made with the same advanced PVC technology as our other products, KLEERWrap Post Wraps encase existing porch posts or columns with a natural wood look that is virtually impervious to moisture and insects. Using Klear PVC adhesives, KLEERWrap Post Wraps can be installed quickly and easily by just one person.

All KLEERWrap mouldings are mitered and cut to length to fit all KLEERWrap Post Wrap sizes.

1 POST WRAP

2 BED MOULDING SET

KLEERWrap Post Wrap comes with two Bed Moulding sets.

3 BASE CAP MOULDING SET

Available separately.

4 OUTER WRAP SET

Available separately.

5 CROWN MOULDING SET

Available separately.

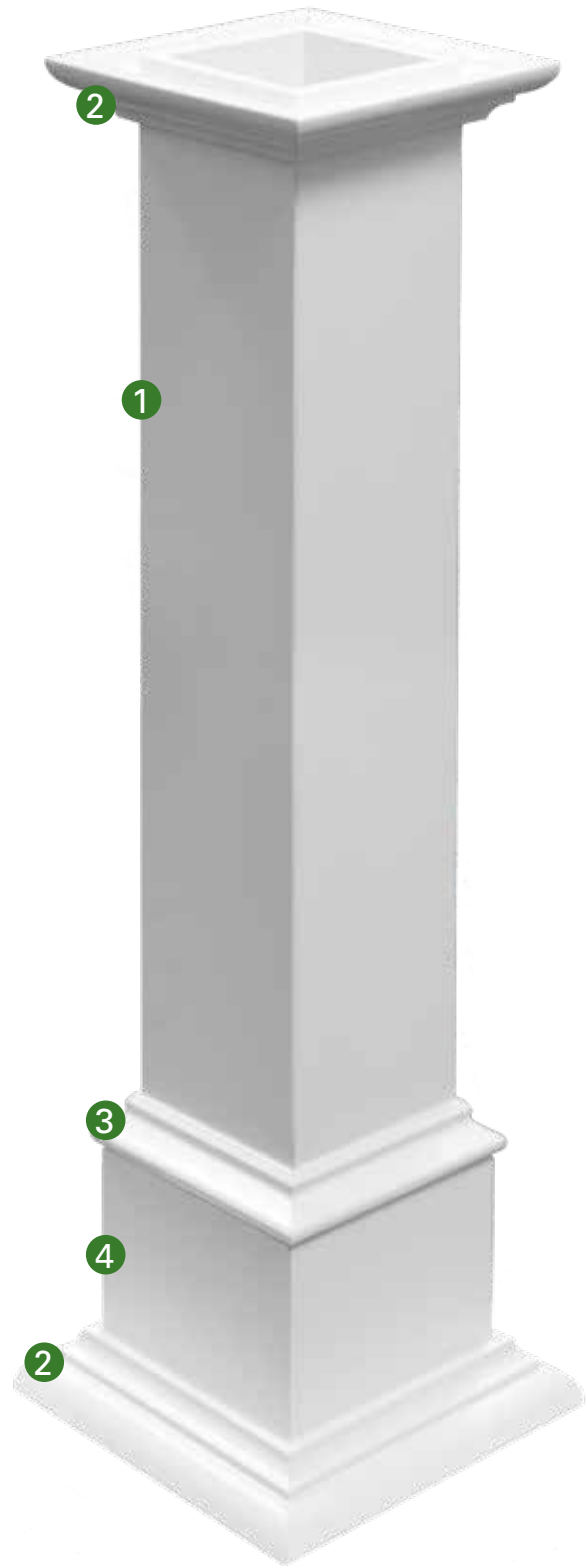

Kleer Post Wraps are easy to install on both new construction and remodeling projects.

KLEER BEADED BOARDS



Tell moisture to take a hike.

Bead board is a timeless look for porch ceilings, soffits, bathrooms, laundry rooms* and other areas that can be prone to moisture. Klear bead board products are made from moisture-resistant PVC material, so no matter where and how you use it, you'll get the look you want with a superior level of curability.



KLEERLok® Beaded Boards

This edge-and-center bead profile features a ship-lap nailing flange that increases installation speed and improves the finished look.



4" KLEERLOK

On-Center Bead reverses to V-Groove
Tongue and Groove



6" KLEERLOK

On-Center Bead reverses to V-Groove
Tongue and Groove



KLEERLOK MOULDING

Used for connecting end joints
of all Klear Beaded products.

Edge and Center Bead Board

This traditional profile replicates the look of tongue and groove wood planks that's ideal for soffits and other applications.

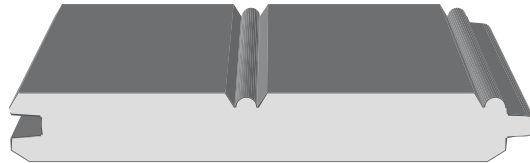

Reverses to V-Groove
Tongue and Groove

KLEERBeed® Beaded Sheets

KLEERBeed Beaded Sheets offer a finished look similar to individual boards, while their larger size makes for fast installation and a consistent surface.



2" On-Center Bead
Tongue and Groove

*Please check local building codes prior to using Klear for indoor applications. Always follow local building codes and construction best practices.

KLEER MOULDINGS®



Breaking the mold for mouldings.

Kleer Mouldings offer all the style and elegance of wood, without any of the hassle or costs of high-maintenance products. Its advanced cellular PVC construction makes cutting and installation easier than ever. And realistic patterns and textures provide long lasting beauty, giving any home's exterior or interior* that consistent, sophisticated look it deserves.



Window Detail

Sill and drip trim for window applications

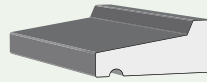

DRIP CAP
#5283P16

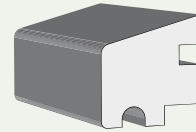

SILL NOSE
#5311P16

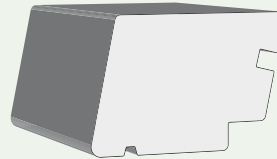

LARGE HISTORIC SILL
#7435C16

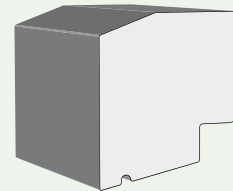

HISTORIC SILL
#7650C16

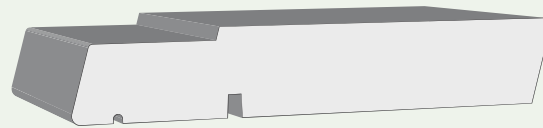

REPLACEMENT SILL
#960810Sill

Casing

Surface application around doors, walls and windows.

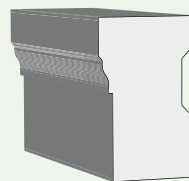

BRICKMOULD
#5180P17, #5180P18, #5180P07,
#5180P10

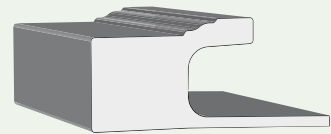

J-CHANNEL BRICKMOULD
#5657P17

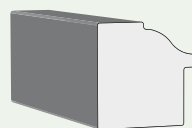

BACK BAND
#7931C16

*Please check local building codes prior to using Kleer for indoor applications. Always follow local building codes and construction best practices.

Detail

Additional trim used to accent primary trim.

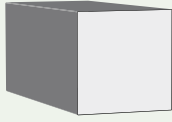

BALUSTER
#5150P12

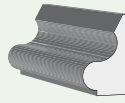

BASE CAP
#5164P16

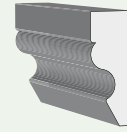

BAND MOULDING
#5168P16

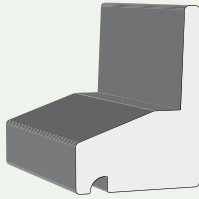

WATER TABLE
#5170C18

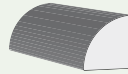

QUARTER ROUND
#5234P16

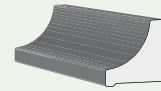

COVE/SCOTIA
#5245P16



WEATHER STOP
#7951C16

Roofing Detail

Trim for rake and fascia.

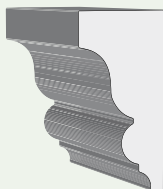

IMPERIAL RAKE
#7962C16

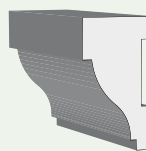

RAKE MOULDING
#5287P16

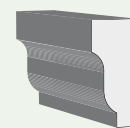

SHINGLE BAND
#5210P16

Crown Mouldings

Used at the intersection of walls and ceilings.

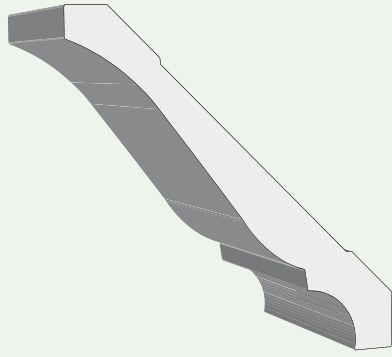

7-1/2" CROWN MOULDING
#5041C16

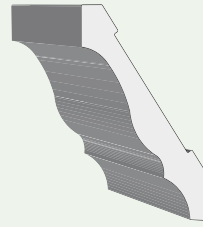

3-5/8" CROWN MOULDING
#5049P16

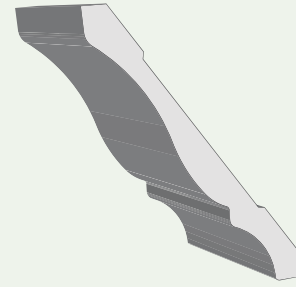

5-1/2" CROWN MOULDING
#5045P16

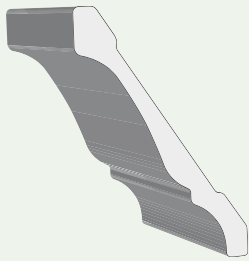

4-5/8" CROWN MOULDING
#5047P16

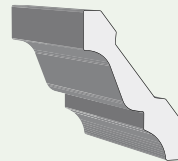

2-3/4" CROWN MOULDING
#5063C16

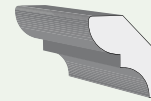

BED MOULDING
#5075P16

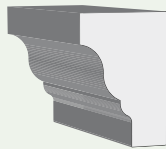

RAMS CROWN
#5158P16

ADHESIVES & FASTENERS

We just love it when building plans come together.

Our adhesives and fasteners have been specially developed to give every Kleer project a seamless, finished look. Fill gaps and nail holes and create tight, weatherproof bonds with Kleer® Adhesives. The Cortex® for Kleer fastening system conceals fastener heads like they don't even exist. If you're using Kleer, use Kleer Adhesives and Fasteners for a perfect finish every time.

Kleer® Adhesives

One adhesive isn't right for every job. That's why we offer both solvent based and two-part adhesives, as well as a structural sealant that performs well beyond standard caulks and nail sticks. Our comprehensive line of Kleer Cellular PVC adhesives and sealants make it easy for builders to install Kleer boards for a look that will last for years to come. These special adhesives have been formulated precisely for use with Kleer Cellular PVC Trim products and are recommended on all Kleer projects.

Kleer Fasteners®

The fastest, easiest way to hide fastener heads when installing Kleer PVC Trim. The finished look of Cortex for Kleer PVC trim is virtually invisible and can be painted if desired. ACO approved.

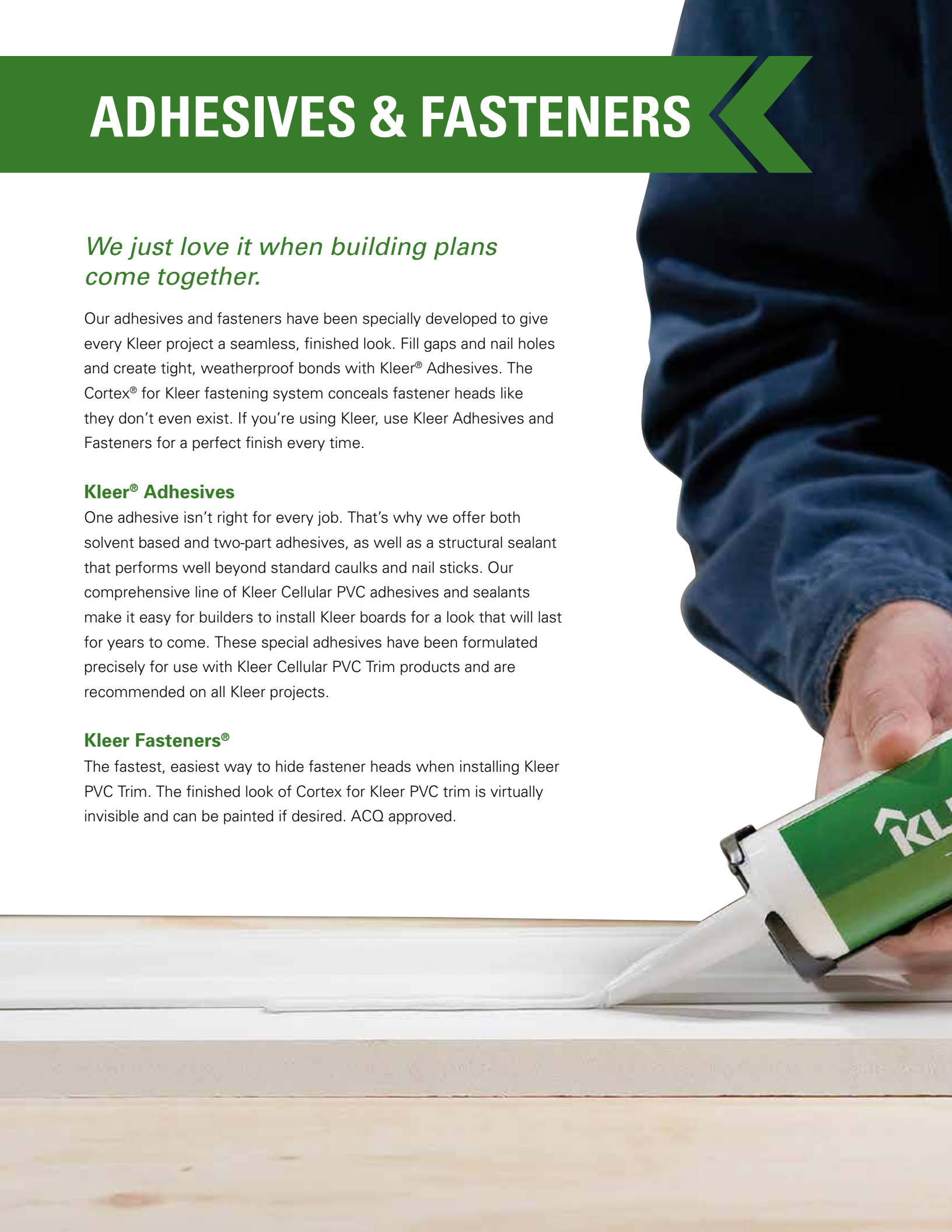

1 Klear Cellular PVC Adhesive

Two-part structural adhesive. 100% waterproof, UV stable, can be sanded and painted, and is color matched to Klear PVC trim products. It can be used to fill nail holes and gaps up to 1/8" without the need for fasteners or biscuits.

20-25 MINUTE WORK TIME.

Ideal for applications where a slower work time is preferred. 25ml, 50ml, and 220ml cartridges

4-7 MINUTE WORK TIME.

50ml and 220ml cartridges

2 Klear PVC Cement

A superior quality, fast-drying adhesive that creates a strong yet flexible bond and provides outstanding resistance to weather and temperature extremes. Color matched to Klear PVC trim products.

4 oz. tube

4 oz., 8 oz., and 16 oz. cans with built-in applicator brushes

3 Klear Structural Sealant

A multi-purpose product. Its tenacious adhesion and elastomeric properties make it the ideal product for filling expansion gaps and filling nail holes. It skins over quickly and can be painted in 2 hours, with a full cure time of roughly one week.

4 Klear Cellular PVC Nail Stick

A two-part epoxy putty used for filling nail holes in PVC. *Cures off-white to light grey.* Sand it, drill it and paint it to make a great finish for any installation.

5 Klear Cellular PVC Laminating Adhesive

A two-part structural adhesive. Lower viscosity for enhanced "flow-out." Requires less clamping pressure for a thin, void-free bond when laminating cellular PVC faces together to create thicker pieces.

220ML cartridges



Kleer Quick Mixer Tips

For use with Kleer Cellular PVC Adhesive. Get the perfect, on-ratio mix each and every time. Designed with a low internal volume for less waste and greater value. 1:1 ratio cartridges for simple and effective application. 24 count.

For 50ml and 220ml cartridges



Kleer Applicator Gun and Kleer Quick Mixer Tip

Kleer Applicator Guns

Used to easily extrude the correct mix of Kleer Cellular PVC Adhesives.

For 50ml and 220ml cartridges



Kleer Caulk Gun Adapter and Kleer Quick Mixer Tip

Kleer Caulk Gun Adapter

Used with a standard caulking gun in place of a Kleer 50ml Applicator Gun to extrude the correct mix from a 50ml cartridge of Kleer Cellular PVC Adhesive.

For 50ml cartridges

Kleer Cellular PVC Cement Thinner

Used to change viscosity or to reactivate dried Kleer Cellular PVC Cement.

16 oz. can



Cortex® Hidden Fastening System

750 LIN. FT.

1,125 screws, 1,200 plugs, and setting tool. 2" length available in smooth finish. 2-3/4" length available in smooth or woodgrain finish.



250 LIN. FT.

375 screws, 400 collated plugs, and setting tool. 2" and 2-3/4" lengths available in smooth or woodgrain finish.



50 LIN. FT.

75 screws, 100 plugs, and setting tool. Smooth or woodgrain finish.



BUILT FOR BUSINESS



If time is money, you're about to cash in.

Our high-quality products minimize callbacks and returns due to manufacturing defects that can slow your projects down. We also have a number of programs to help reduce your costs and grow your business.

Sales Support

At Klear, we pride ourselves in developing relationships with our builders, contractors and architectural customers that help them build their businesses for years to come. Our in-market sales team will work side-by-side with you to make sure our products get you the best possible results.

KlearBucks and Rebate Programs

If you're a first-time customer or long-time loyal customer you can get a rebate for purchases made on Klear products.

Model Home Program

Building a model home? You can get a credit on Klear purchases used on your model home.

Architect Meetings

Westlake Royal Building Products holds regular virtual and in-person architect meetings to provide vital information and demos for different building materials. As a registered provider with The American Institute of Architects Continuing Education Systems, attendees can earn AIA credits upon completion of this program.

MULTIFAMILY



Who would have thought trimboard could be a property manager's best friend?

The single biggest issue with managing multi-family properties is maintenance costs. Reduce them and you can increase your profitability. Kleer products are easy to install, similar to wood, and can be put up quickly with low maintenance and few callbacks. They also won't rot or fade, and because they don't need to be painted, they won't need to be repainted again and again. Kleer can be combined with a wide range of building products, especially other specialty siding, shutters and accessories from Westlake Royal Building Products. Build your multi-family properties for the long run with Kleer.



STAY CONNECTED

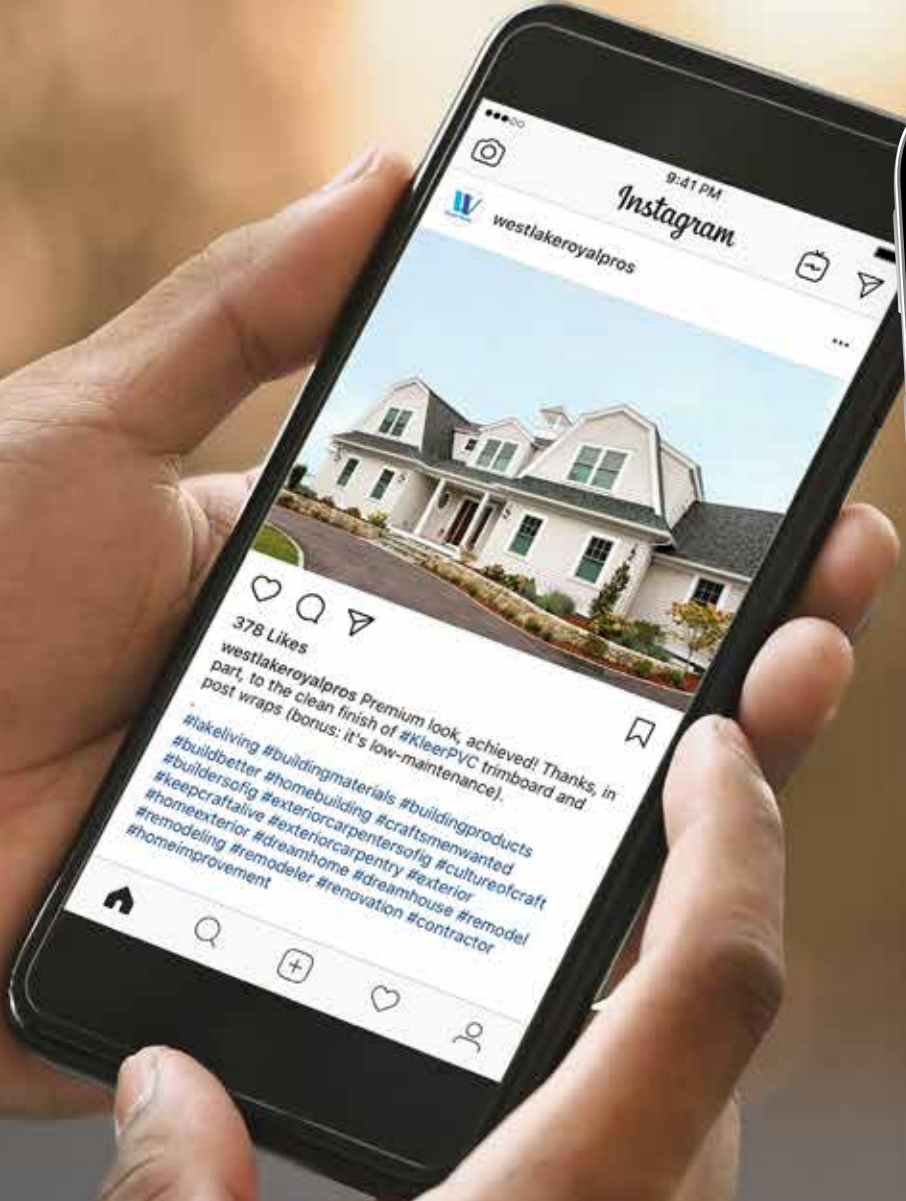

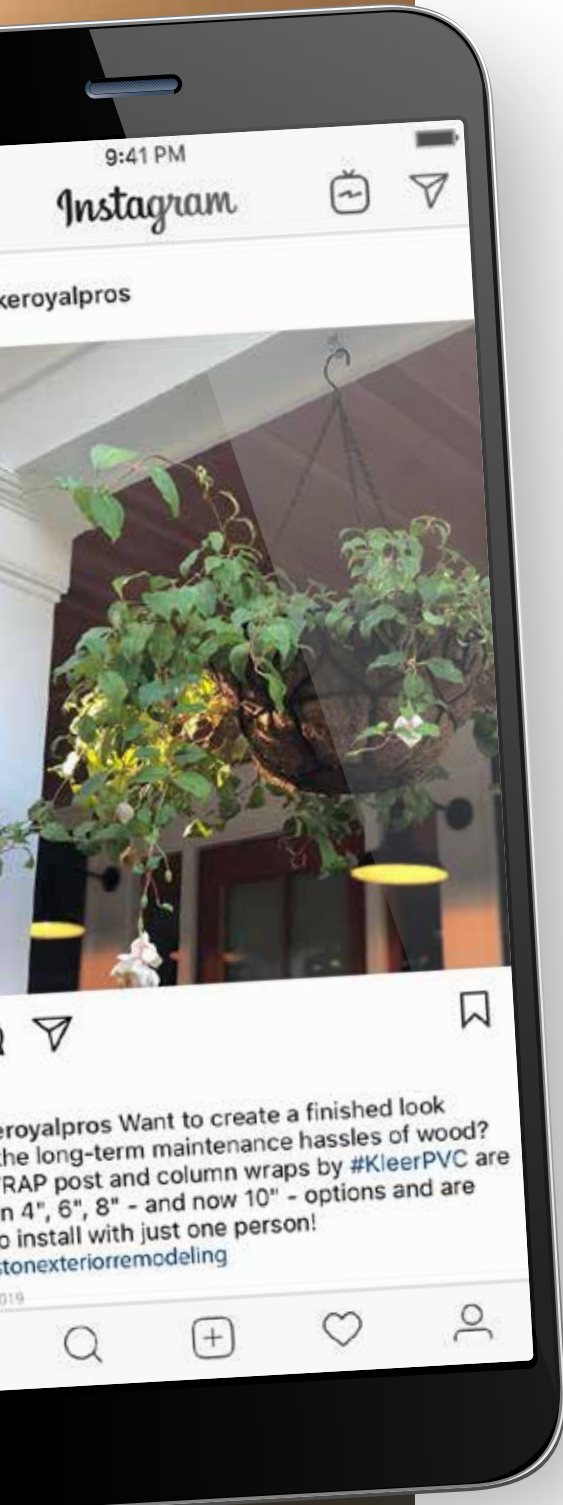

Get the latest from Westlake Royal Building Products

Follow us on Facebook, Twitter and Instagram for ideas and inspiration on how you can use Kleer and other products from Westlake Royal Building Products.

We want to see what you've been up to.

We're always impressed by what contractors can do with our trimboards, wraps, bead boards and mouldings. We want to see your handiwork. When you use Kleer on a project, snap a picture and share with us on our social channels. We'll share it with all our followers and give you credit for a job well done.

Kleer Trimboard®

Available in smooth and woodgrain finish.

THICKNESS	AVAILABLE LENGTHS		AVAILABLE WIDTHS (ACTUAL)								TRUEEDGE®	
	18'	20'	3(2-1/2")	4(3-1/2")	5(4-1/2")	6(5-1/2")	8(7-1/4")	10(9-1/4")	12(11-1/4")	16(15-1/4")		
5/8"	■		■	■	■	■	■	■	■	■	■	■
3/4"	■		■	■	■	■	■	■	■	■	■	■
15/16"	■	■	■	■	■	■	■	■	■	■	■	■
1-1/4"	■		■	■	■	■	■	■	■	■	■	■

Kleer Trimboard® with Nailing Flange Cutouts

Available in smooth and woodgrain finish.

THICKNESS	LENGTH	AVAILABLE WIDTHS (ACTUAL)	
		4 (3-1/2")	6 (5-1/2")
15/16"	18'	■	■

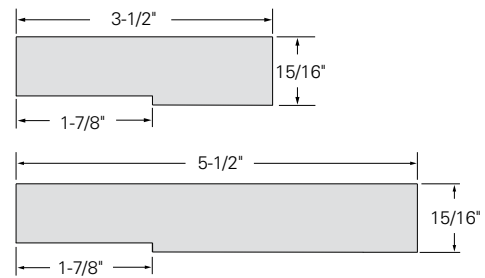

3-1/2" Flat with J

Smooth finish.

NOMINAL SIZE	ACTUAL SIZE	LENGTH
5/4 x 4	1-1/8" x 3-1/2"	16' ■

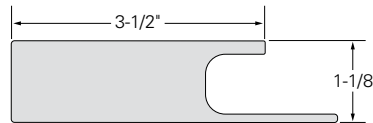

Outside Corner with Integrated Nailing Flange

Smooth finish.

DESCRIPTION	ACTUAL SIZE	LENGTH
4 x 4	3-1/2" x 3-1/2"	20' ■
6 x 6	5-1/2" x 5-1/2"	■

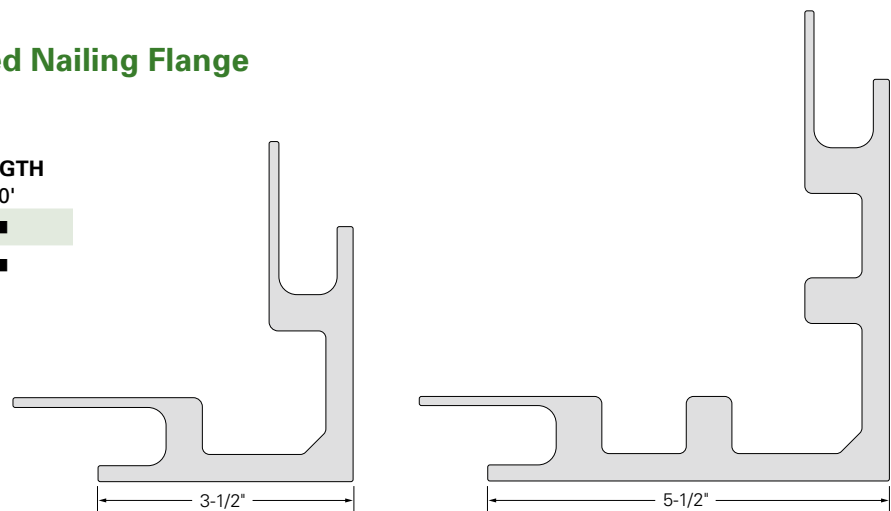

Kleer Corners®

Available in smooth and woodgrain finish.

DESCRIPTION	NOMINAL SIZE	ACTUAL SIZE	AVAILABLE LENGTHS	
			10'	20'
Kleer Corners®	5/4 x 4	15/16" x 3-1/2"	■	■
Kleer Corners®	5/4 x 6	15/16" x 5-1/2"	■	■

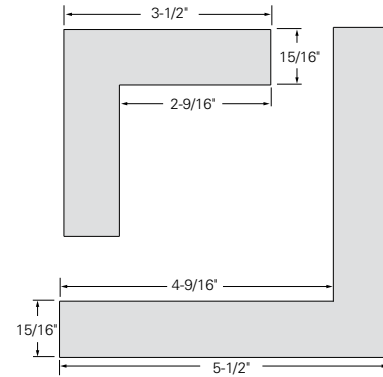

KLEERStart®

Available in smooth and woodgrain finish.

THICKNESS	LENGTH	AVAILABLE WIDTHS (ACTUAL)	
		6 (5-1/2")	8 (7-1/2")
3/4"	18'	■	■

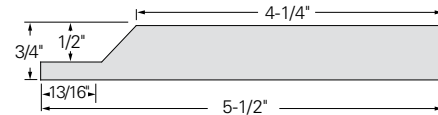

Kleer Konceal®

Available in smooth and woodgrain finish.

DESCRIPTION	NOMINAL SIZE	ACTUAL SIZE	AVAILABLE LENGTHS			
			10'	16'	18'	20'
Kleer Konceal® Trimboard	5/4 x 4	15/16" x 3-1/2"			■	
Kleer Konceal® Trimboard	5/4 x 6	15/16" x 5-1/2"			■	
Kleer Konceal® Trimboard with Nailing Flange Cutout	5/4 x 4	15/16" x 3-1/2"			■	
Kleer Konceal® Trimboard with Nailing Flange Cutout	5/4 x 6	15/16" x 5-1/2"			■	
Kleer Konceal® Corners	5/4 x 4	15/16" x 3-1/2"	■			■
Kleer Konceal® Corners	5/4 x 6	15/16" x 5-1/2"	■			■

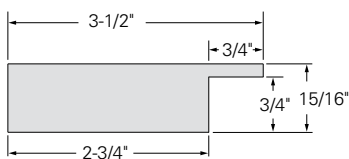

KLEER KONCEAL® TRIMBOARD

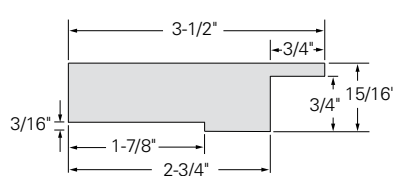

KLEER KONCEAL® TRIMBOARD WITH NAILING FLANGE CUTOUT

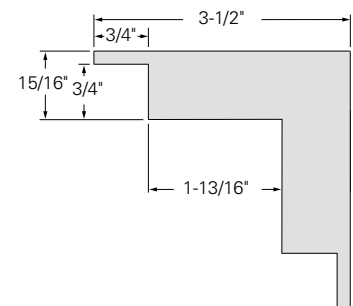

KLEER KONCEAL® CORNER

Kleer Sheets®

Reversible smooth/woodgrain finish.

THICKNESS	WIDTH	AVAILABLE LENGTHS					
		4'	8'	10'	12'	18'	20'
1/4"	■	■	■	■	■		
3/8"	■	■	■	■	■	■	
1/2"	■	■	■	■	■	■	
5/8"	■	■	■	■	■	■	
3/4"	■	■	■	■	■	■	■
15/16"	■	■	■	■	■	■	■

Custom widths and lengths available. Please check with your local dealer for product availability in your market.

Kleer Custom Sheets

Reversible smooth/woodgrain finish.

THICKNESS	WIDTH	AVAILABLE LENGTHS					
		8'	10'	12'	16'	18'	20'
1-1/4"	4* ■	■	■	■	■	■	■

*Nominal 48", Actual 47" ± 3/4"

Custom widths and lengths available. Please check with your local dealer for product availability in your market.



KLEERWrap® Post Wraps

Smooth finish.

DESCRIPTION	AVAILABLE LENGTHS		INSIDE DIMENSION (ACTUAL)	OUTSIDE DIMENSION (ACTUAL)	POST SIZE (NOMINAL)
	8'	10'			
4" Post Wrap	■	■	3-3/4" x 3-3/4"	4-1/2" x 4-1/2"	4" x 4"
6" Post Wrap	■	■	5-3/4" x 5-3/4"	6-1/2" x 6-1/2"	6" x 6"
8" Post Wrap		■	6-1/2" x 6-1/2"	7-1/4" x 7-1/4"	6" x 6"
10" Post Wrap		■	8-1/4" x 8-1/4"	9-1/4" x 9-1/4"	8" x 8"

KLEERWrap® Outer Wrap

Smooth finish.

DESCRIPTION	AVAILABLE LENGTHS			INSIDE DIMENSION (ACTUAL)	OUTSIDE DIMENSION (ACTUAL)	THICKNESS (ACTUAL)
	5'	7'	12'			
4" Outer Wrap	■	■	■	4-1/2" x 4-1/2"	5-1/2" x 5-1/2"	1/2"
6" Outer Wrap	■	■	■	6-1/2" x 6-1/2"	7-1/2" x 7-1/2"	1/2"
8" Outer Wrap	■	■	■	7-1/4" x 7-1/4"	8-1/4" x 8-1/4"	1/2"
10" Outer Wrap	■	■	■	9-1/4" x 9-1/4"	10-1/4" x 10-1/4"	1/2"

KLEERWrap® Mouldings

Smooth finish. All KLEERWrap mouldings are mitered and cut to length to fit all KLEERWrap Post Wrap sizes.

DESCRIPTION	AVAILABLE FOR POST WRAP SIZES				AVAILABLE FOR OUTER WRAP SIZES			
	4"	6"	8"	10"	4"	6"	8"	12"
Bed Moulding Set*	■	■	■	■	■	■	■	■
Base Cap Moulding Set	■	■	■	■				
Crown Moulding Set	■	■	■	■				

*Each KLEERWrap Post Wrap comes with two Bed Moulding Sets. Additional moulding sets purchased separately.

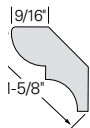

BED MOULDING

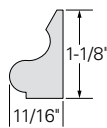

BASE CAP MOULDING

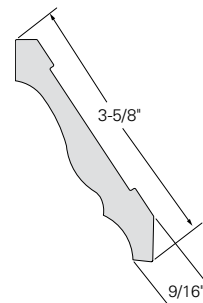

CROWN MOULDING

Beaded Boards

Smooth finish.

DESCRIPTION	SIZE (ACTUAL)	LENGTH				ON-CENTER BEAD	REVERSES TO V-GROOVE
		8'	10'	16'	18'		
4" KLEERLok® Beaded Board	1/2" x 3-1/4"			■		1-5/8"	■
6" KLEERLok® Beaded Board	1/2" x 5"			■		2-1/2"	■
KLEERLok® Moulding	5/8" x 2-1/2"			■		—	—
Edge and Center Bead Board	3/4" x 6"				■	2-1/2"	■
KLEERBeed® Beaded Sheet	1/2" x 48"	■	■			2"	

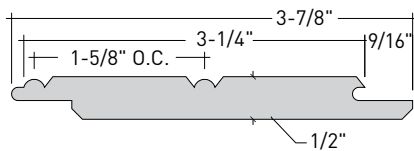

4" KLEERLOK® BEADED BOARD

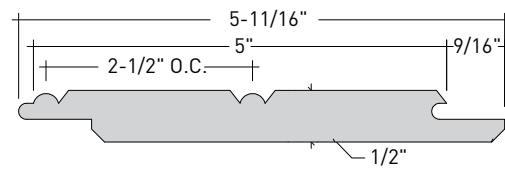

6" KLEERLOK® BEADED BOARD

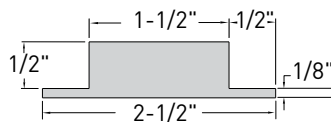

KLEERLOK® MOULDING

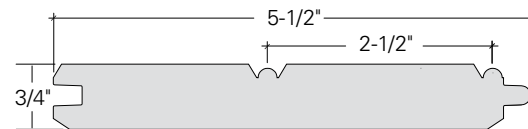

EDGE AND CENTER BEAD BOARD

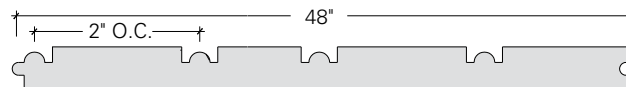

KLEERBEED® BEADED SHEETS

Mouldings: Window Detail

Smooth finish.

DESCRIPTION	PART NUMBER	SIZE (ACTUAL)	LENGTH	PIECES/BUNDLE
Drip Cap	#5283P16	1 1/16" x 1-5/8"	16'	12
Sill Nose	#5311P16	1-3/8" x 1-5/16"	16'	8
Large Historic Sill	#7435C16	1-25/32" x 2-11/16"	16'	4
Historic Sill	#7650C16	1-3/4" x 2-1/32"	16'	4
Replacement Sill	#960810Sill	1-1/4" x 7-1/4"	10'	2

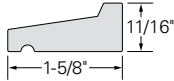

DRIP CAP
#5283P16

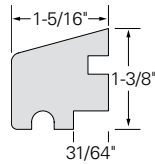

SILL NOSE
#5311P16

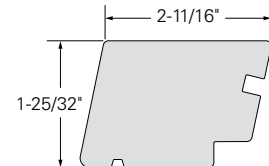

LARGE HISTORIC SILL
#7435C16

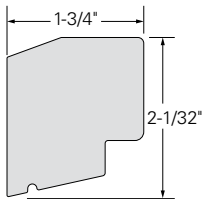

HISTORIC SILL
#7650C16

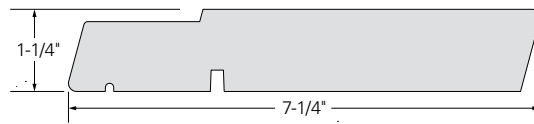

REPLACEMENT SILL
#960810Sill

Mouldings: Casing

Smooth finish.

DESCRIPTION	PART NUMBER	SIZE (ACTUAL)	LENGTH	PIECES/BUNDLE
Brickmould	#5180P17	1-1/4" x 2"	17'	8
Brickmould	#5180P18	1-1/4" x 2"	16'	8
Brickmould	#5180P07	1-1/4" x 2"	7'	8
Brickmould	#5180P10	1-1/4" x 2"	10'	8
J-Channel Brickmould	#5657P17	1-1/4" x 3"	17'	6
Back Band	#7931C16	1-11/32" x 1-3/16"	16'	10

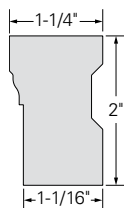

BRICKMOULD
#5180P17, #5180P18, #5180P07, #5180P10

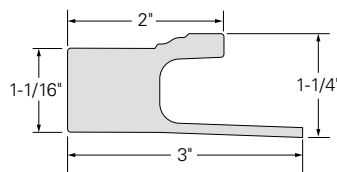

J-CHANNEL BRICKMOULD
#5657P17

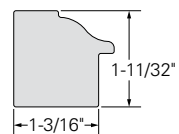

BACK BAND
#7931C16

Mouldings: Detail

Smooth finish.

DESCRIPTION	PART NUMBER	SIZE (ACTUAL)	LENGTH	PIECES/BUNDLE
Baluster	#5150P12	1-1/2" x 1-1/2"	12'	6
Base Cap	#5164P16	1-3/8" x 1-5/16"	16'	8
Band Moulding	#5168P16	5/8" x 1-3/4"	16'	10
Water Table	#5170C18	3/4" x 2"	18'	4
Quarter Round	#5234P16	3/4" x 3/4"	16'	20
Cove/Scotia	#5245P16	3/4" x 3/4"	16'	46
Weather Stop	#7951C16	3/8" x 1-31/32"	16'	12

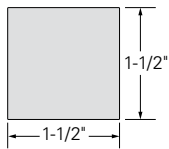

BALUSTER
#5150P12

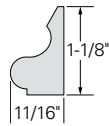

BASE CAP
#5164P16

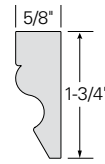

BAND MOULDING
#5168P16

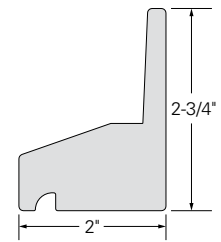

WATER TABLE
#5170C18

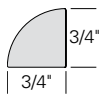

QUARTER ROUND
#5234P16



COVE/SCOTIA
#5245P16

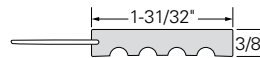

WEATHER STOP
#7951C16

Mouldings: Roofing Detail

Smooth finish.

DESCRIPTION	PART NUMBER	SIZE (ACTUAL)	LENGTH	PIECES/BUNDLE
Imperial Rake	#7962C16	1-3/8" x 2-3/4"	16'	8
Rake Moulding	#5287P16	1-1/16" x 2"	16'	10
Shingle Band	#5210P16	11/16" x 1-5/8"	16'	10

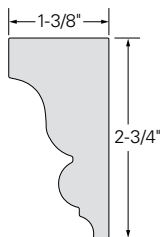

IMPERIAL RAKE
#7962C16

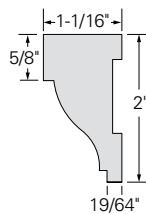

RAKE MOULDING
#5287P16

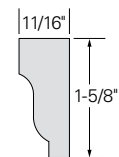

SHINGLE BAND
#5210P16

Mouldings: Crown Mouldings

Smooth finish.

DESCRIPTION	PART NUMBER	SIZE (ACTUAL)	LENGTH	PIECES/BUNDLE
7-1/2" Crown Moulding	#5041C16	1-3/32" x 7-17/32"	16'	2
5-1/2" Crown Moulding	#5045P16	9/16" x 5-1/2"	16'	8
4-5/8" Crown Moulding	#5047P16	5/8" x 4-5/8"	16'	11
3-5/8" Crown Moulding	#5049P16	9/16" x 3-5/8"	16'	10
2-3/4" Crown Moulding	#5063C16	9/16" x 2-3/4"	16'	10
Bed Moulding	#5075P16	9/16" x 1-5/8"	16'	10
Rams Crown	#5158P16	1-13/32" x 2"	16'	6

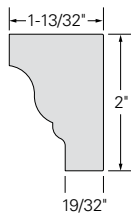
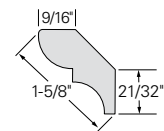
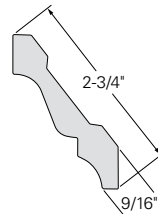
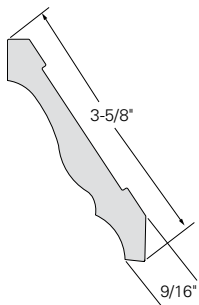
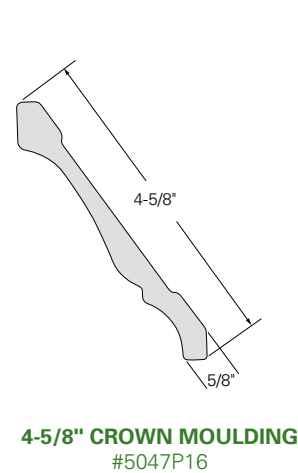
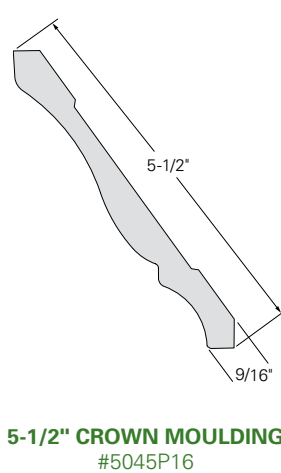
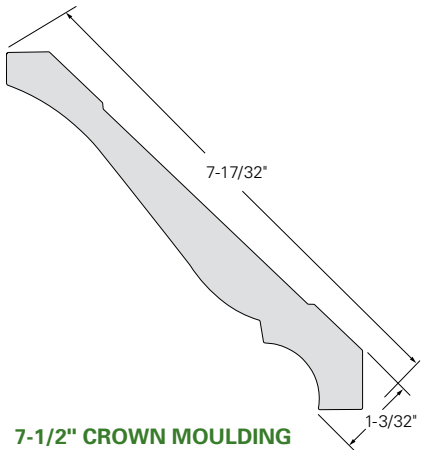



KleerLumber.com
800.521.8486



NAHB
NATIONAL ASSOCIATION
OF HOME BUILDERS



NARI
NATIONAL ASSOCIATION OF
THE REMODELING INDUSTRY



CAD details



CODE
COMPLIANCE
CCRR-0237

Westlake

Royal Building Products™

WestlakeRoyalBuildingProducts.com

© 2022 Westlake Royal Building Products

SIDING & ACCESSORIES
TRIM & MOULDINGS
ROOFING
STONE
WINDOWS
OUTDOOR LIVING

Item # KL036 | K49550 5/22